

Section I – Installation Preparation

Part Number: 08457-52800

Section I – Installation Preparation

Kit Contents

Item #	Quantity Req'd.	Description
1	1	Alloy Wheel Painted

Hardware Bag Contents

Item #	Quantity Req'd.	Description
1	1	Center Cap Painted (08402-52801)
2	4	Lug Nuts (90942-01062)
3	1	Valve Stem (TR413)

Additional Items Required For Installation

Item #	Quantity Req'd.	Description
1	As Required	Balance Weights Clip-on Type (Hofmann Standard)
2	As Required	Balance Weights Stick-on Type (Hofmann Standard)

Conflicts

Note:

Recommended Tools

Safety Tools	
Safety Glasses	
Seat Protection	Blanket
Special Tools	
Wheel Balancing Machine	Hunter DSP9700 (preferred), DSP9500 or equivalent
Tire Mounting Machine	Hunter TC3250 or Equivalent
Centering Cone	Hunter 192-51-2
Foot Brake Application Tool	Snap-on B240A Pedal Jack or equivalent
Surface Thermometer	Infrared Non-contact
Installation Tools	
Valve Stem Insertion Tool	
Lug Nut Wrench	
Rubber Mallet	
Torque Wrench	0-250 lbf•ft (340 N•m)
Socket	21 mm Deep Well
Balance Weight Pliers	
Clean Lint-free Cloth	
Wire Brush	
Nylon Panel Removal Tool	e.g. Panel Pry Tool #1 Toyota SST # 00002-06001-01
Grease Pen	

Special Chemicals	
Tire Lube – “Sliptac”	Myers Tire Supply
Cleaner (for rework only)	3M™ Prep Solvent 70

General Applicability





Applicable to xB Use with tire size 185/65-R15

Recommended Sequence of Application

Item #	Accessory	
1	Alloy Wheel	
2	Wheel lock	





*Mandatory

Legend

	STOP: Damage to the vehicle may occur. Do not proceed until process has been complied with.
	OPERATOR SAFETY: Use caution to avoid risk of injury.
	CRITICAL PROCESS: Proceed with caution to ensure a quality installation.
	GENERAL PROCESS: This highlights specific processes to ensure a quality installation.
	TOOLS & EQUIPMENT: Calls out the specific tools and equipment recommended for this process.

Section II – Installation Procedure

A. Vehicle Preparation

-  1. Firmly apply parking brake. (Fig. A-1)
-  2. Put transmission in “P”(Automatic) or reverse (Manual). (Fig. A-2)
- 3. Add seat protection (blanket) and apply foot brake using foot brake application tool. (Fig. A-3)
- 4. Lift vehicle.
-  5. Remove OE wheel and tire assembly from vehicle. Wear safety glasses while removing wheels. (Fig. A-4)
-   6. If required remove any corrosion on the mounting surface of the vehicles with a wire brush. Wear safety glasses to protect against dust. (Fig. A-5)
- 7. Dismount OE tire from the wheel.

B. Wheel Balancing – Low Weight Spot

- 1. Using the valve stem insertion tool, install valve stem on alloy wheels. Use a clean lint free cloth while using the tool to prevent scratches on the wheel surface.
- 2. Set wheel-balancing machine to STATIC MODE. Operate machine and mark low weight spot on wheel with grease pen.

NOTE: Refer to wheel balance manual for specific details of this operation.

C. Wheel Mounting

-  1. Use tire lube on tire bead and bead location on wheel prior to mounting the tire. Remount OE tire on alloy wheel, matching tire heavy spot (red dot) with that of wheel low weight spot identified in Step B. 2..



Fig. A-1

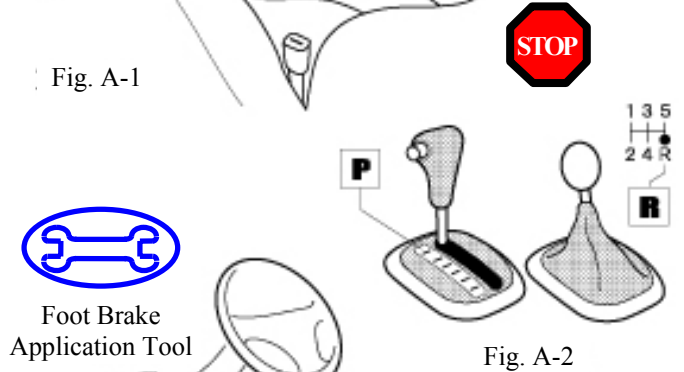

Fig. A-2



Foot Brake Application Tool

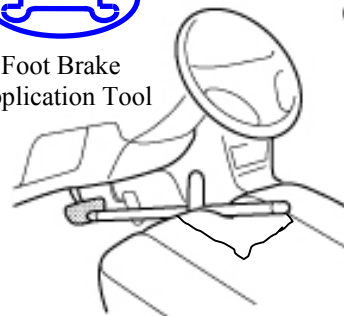

Fig. A-3



Lug nut

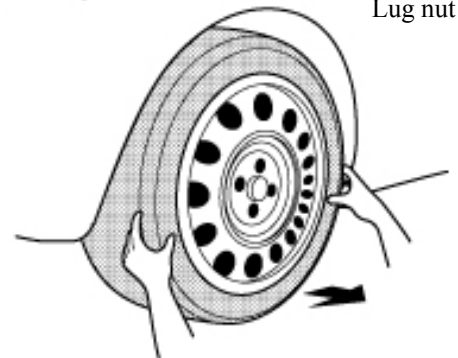

Fig. A-4



Wire Brush

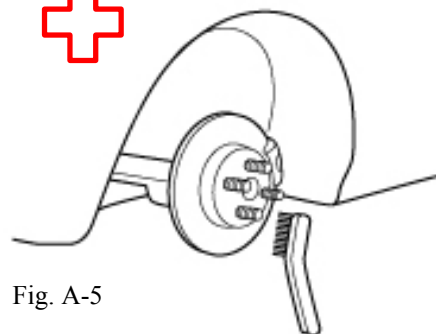

Fig. A-5

2. The alignment of the marking must be within +/- 15 mm center to center (Fig. C-1)



3. To seat tire bead, inflate tire beyond 32 PSI but not more than the maximum tire bead seat pressure indicated on the tire sidewall. If it is not indicated use 40 PSI as a limit. If tire bead is not seated when pressure registers 40 PSI, deflate the tire and re-inflate to seat the bead. Regulate tire pressure to 40 PSI.

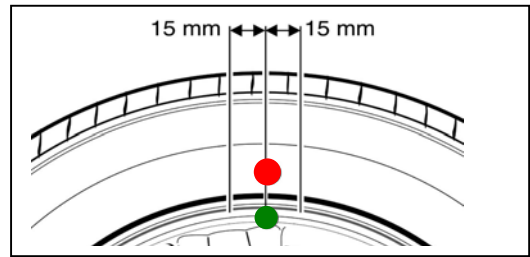

Fig. C-1

D. Wheel Balancing

NOTES: Application temperature for stick-on type weight is above 10°C (50°F). It is good practice to apply the stick-on type in sections comprised of no more than 5 or 6 individual weight segments.



1. Mount wheel /tire on wheel balance machine and balance in DYNAMIC MODE. Enable the LOAD ROLLER, if applicable, to ensure proper bead seating. Use clip-on type balance weight on the inner rim lip and stick-on type weights at outer location. (Fig. D-1 & D-2)



2. Prior to mounting stick-on type, wipe down the weight mounting location on wheel with a clean, lint-free dry cloth to ensure that the location is clean and dry. Apply stick-on type weights at perimeter location identified by dynamic balance machine as shown. Use rubber mallet, if required, to achieve complete adhesion of stick-on type weight.

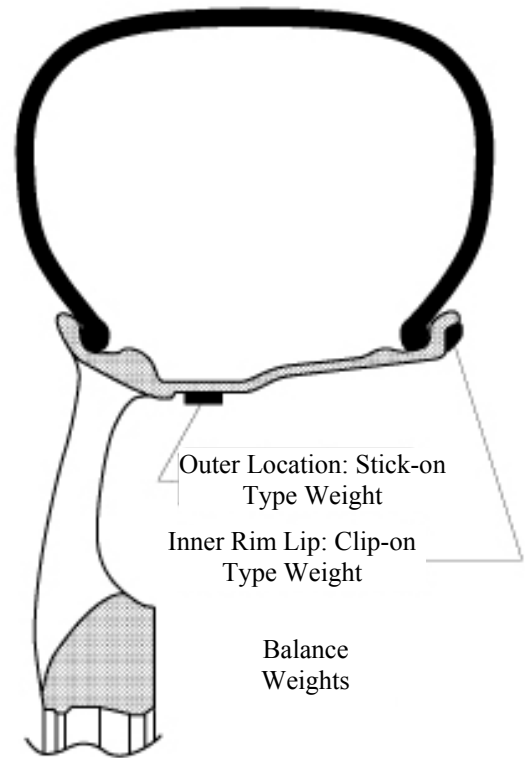
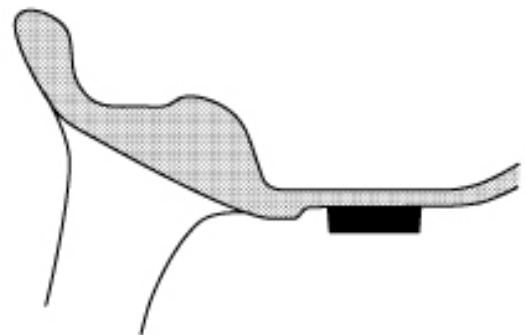

Fig. D-1

NOTES: Maximum clip-on type weight on inner lip is 80g. Maximum stick type weight at outer location is 98g. If removal and replacement of stick type weight is necessary, then remove the weight using a nylon removal tool. Clean the surface with clean cloth using 3M™ Prep Solvent-70. Wipe the surface dry before re-applying a new weight. **DO NOT RE-USE STICK-ON WEIGHTS.**



Detail of Outer Location – Stick-on Type Weight

Fig. D-2

Section II – Installation Procedure

3. Re-spin the wheel on the machine with LOAD ROLLER DISABLED (if applicable) and note the indicated remaining unbalance. The maximum permitted unbalance is 8g at inner lip and 8g at outer location. If the indicated unbalance is not within permissible limit, carefully remove the balance weights using the balance weight pliers (for clip-on type weight) or nylon removal tool (for stick-on type weight) and re-balance the wheel.

E. Vehicle Wheel/Tire installation

- ➔ 1. Install wheel/tire assembly on vehicle. Hand start the lug nuts during installation. Tighten lug nuts in sequence 1 through 4 (Fig. E-1). Ensure that the socket does not scuff the wheel. Tighten to 76 lbf•ft (103 N•m) using a torque wrench.
2. Lower the vehicle.
- ⚠ 3. Tire pressure should be adjusted to the value recommended in the owner’s manual for this vehicle. Install valve stem cap.

F. Center Cap Installation

- ⚠ 1. Install center caps on wheels. Gently push cap into wheel until cap snaps into place. Ensure that center cap clip is corrected located adjacent to valve stem as shown. (Fig. F-1).

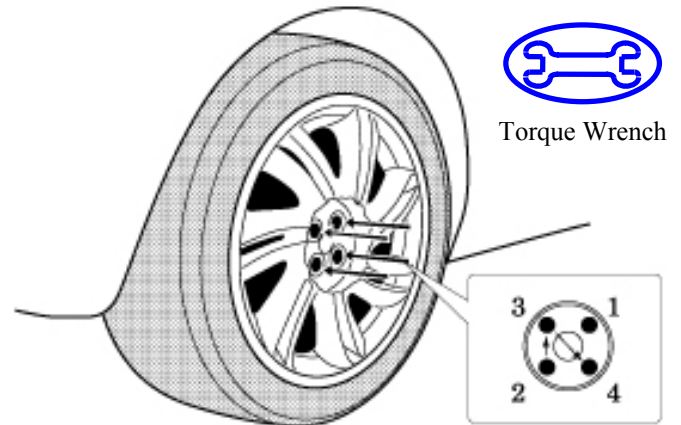

Fig. E-1

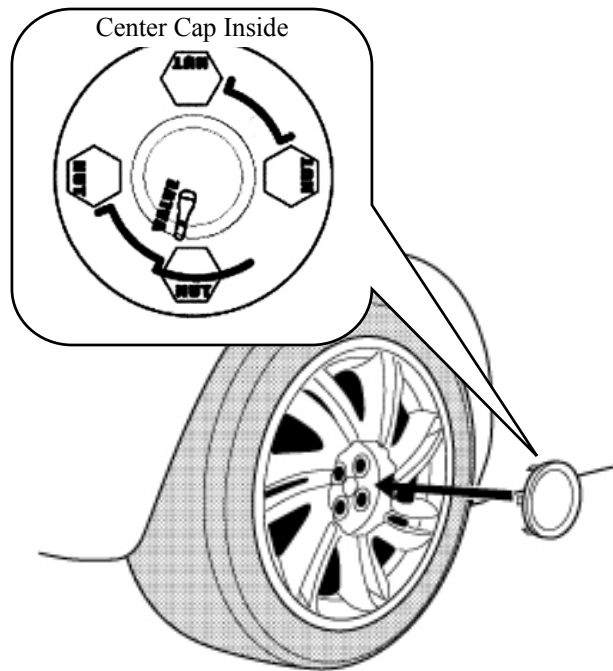

Fig. F-1

Section III – Functional Verifications



Section III – Functional Verifications

Check: _____

Inspect lug nuts

Lug nut tightness

Look For: _____

Four lug nuts must be installed on each wheel.

Tighten to 76 lbf•ft (103 N•m) torque.