

Preparation

Part Number: PK389-42K00P1/TP (BASE)
PK389-42K01P1/TP (ADV/TRAIL)

Kit Contents

Item #	Quantity Req.	Description
1	1	Front Passenger Side Mudguard
2	1	Front Driver Side Mudguard
3	1	Rear Passenger Side Mudguard
4	1	Rear Driver Side Mudguard
5	1	Hardware Kit (Front)
6	1	Hardware Kit (Rear)

Recommended Sequence of Application

Item #	Accessory
1	Running Boards
2	Mudguards
3	

*Mandatory

Hardware Bag Contents

Item #	Quantity Req.	Description
Front (1 Bag)		
1	4	#14 x 19mm Screw (Thick)
2	2	Push Pin (Small)
3	2	Push Pin (Large)
Rear (1 Bag)		
1	6	M5 x 20mm Screw (Thin)
2	2	#14 x 19mm Screw (Thick)
3	6	Spring Clip (Small)

Vehicle Service Parts (may be required for reassembly)

Item #	Quantity Req.	Description
1		
2		
3		

Additional Items Required For Installation

Item #	Quantity Req.	Description
1		

Conflicts

Ground effects

Recommended Tools

Personal & Vehicle Protection	Notes
None	
Special Tools	Notes
Temperature gun	
Installation Tools	Notes
90 Degree Angled driver	Phillips #2, #3
90 Degree Socket Driver	6mm (1/4"), 10mm (3/8")
Extension	3"
Nylon removal tool	
Clean Cloth/Rag	
Special Chemicals	Notes
Cleaner	VDC approved

General Applicability

All MY19 and newer RAV4 vehicles

Legend

 **STOP:** Damage to the vehicle may occur. Do not proceed until process has been complied with.

 **OPERATOR SAFETY:** Use caution to avoid risk of injury.

 **CAUTION:** A process that must be carefully observed in order to reduce the risk of damage to the accessory/vehicle and to ensure a quality installation.

 **TOOLS & EQUIPMENT:** Used in Figures calls out the specific tools and equipment recommended for this process.

 **REVISION MARK:** This mark highlights a change in installation with respect to previous issue.

 **SAFETY TORQUE:** This mark indicates that torque is related to safety.

Procedure

Care must be taken when installing this accessory to ensure damage does not occur to the vehicle. The installation of this accessory should follow approved guidelines to ensure a quality installation.

These guidelines can be found in the "Accessory Installation Practices" document.

This document covers such items as:-

- Vehicle Protection (use of covers and blankets, cleaning chemicals, etc.).
- Safety (eye protection, rechecking torque procedure, etc.).
- Vehicle Disassembly/Reassembly (panel removal, part storage, etc.).
- Electrical Component Disassembly/Reassembly (battery disconnection, connector removal, etc.).

Please see your Toyota dealer for a copy of this document.

1. Start with vehicle on lift.

2. Clean the Front Mounting Area

-  (a) Clean and degrease the front body panel where the mudguard is to be located with a clean cloth and soap/water mixture (Fig. 2-1).

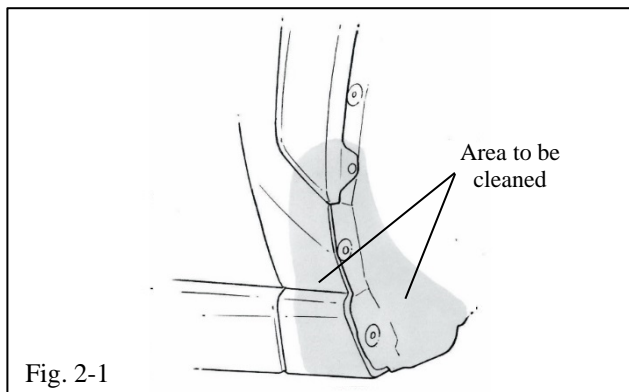

3. Remove the Front Hardware

- (a) Remove existing push pin location A and discard (Fig. 3-1).
- (b) Remove existing lower push pin location D and discard.

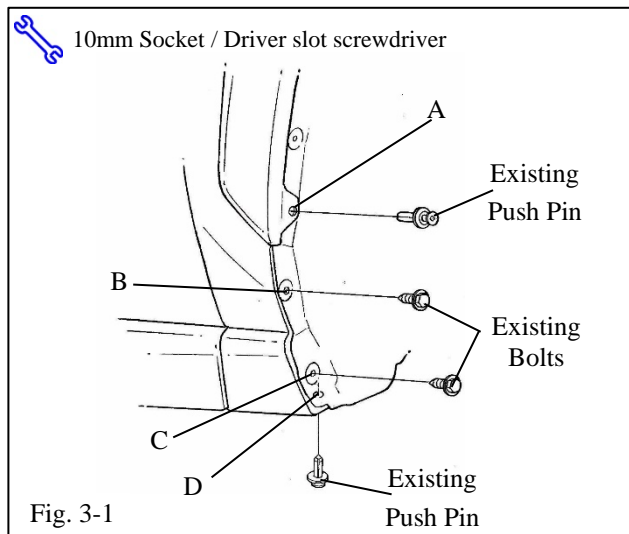

4. Install the Front Mudguard.

⚠ NOTE: Sequence is optional.

- (a) While holding the part up and into body panel, mount the mudguard on body panel and install supplied #14 x 19mm (Thick) screw in location B and C (Fig. 4-1).

⚠ NOTE: Do not overtighten the screw.

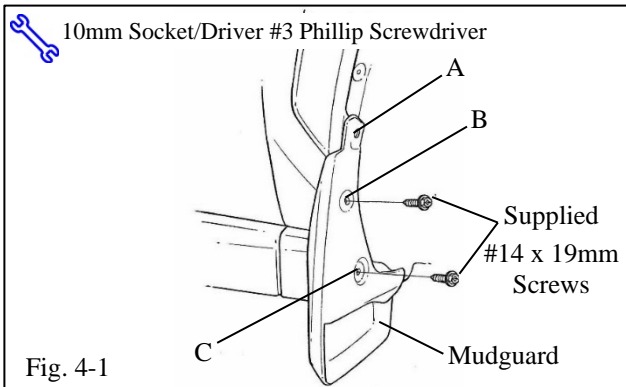

- (b) Install supplied push pin (small) in location A while holding part up and into body panel (Fig. 4-2).

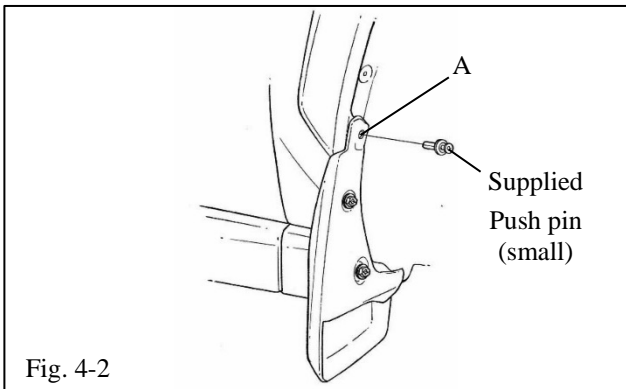

- (c) While holding mudguard tight to panel and liner install supplied push pin (Large) in location D (Fig 4-3).

- (d) Repeat procedure for other side.

⚠ NOTE: Do not overtighten the screw.

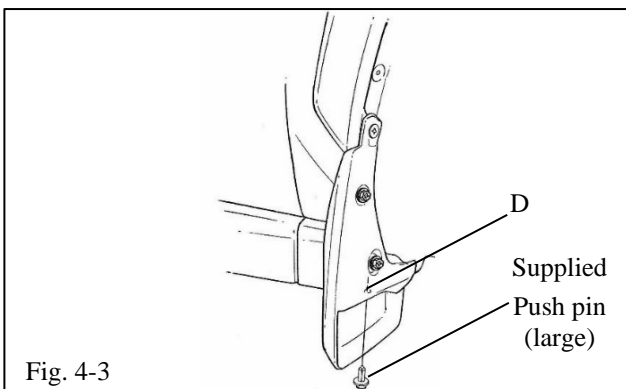

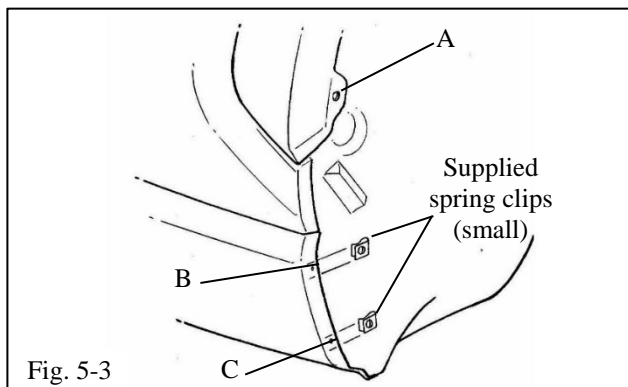
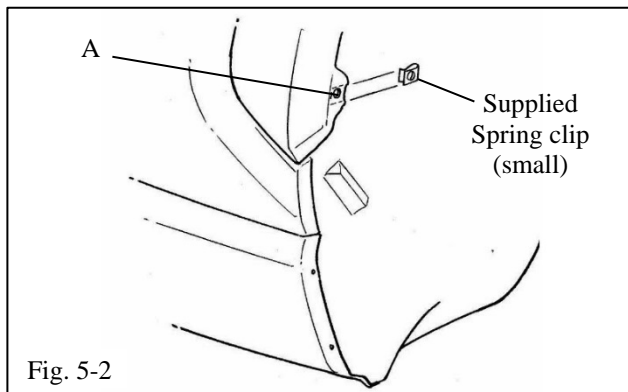
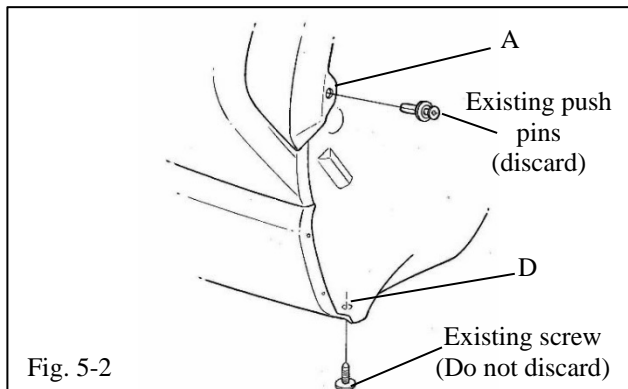
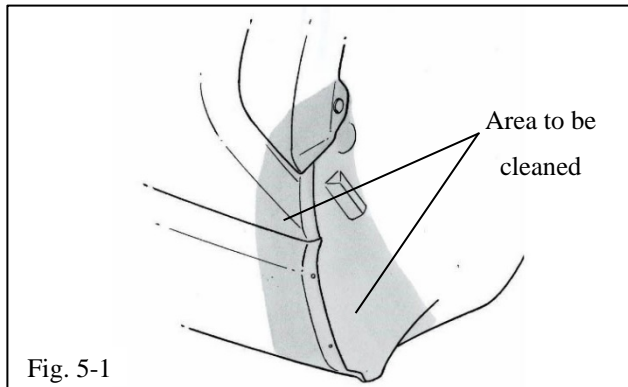



5. Clean the Rear Mounting Area.

- (a) Clean and degrease the rear bumper panel where the mudguard is to be located with a clean cloth and soap/water mixture (Fig. 5-1).

6. Remove and Install the Rear Hardware.

- (a) Remove existing push pin location A and discard (Fig. 5-2).
-  (b) Remove existing lower bolt location D. Do not discard.

- (c) Pull flare out at location A and install supplied spring clip (small) with turned up edge inside liner and install clip through access slot in liner (Fig 5-2).

 **NOTE:** Install the spring clip on the liner not flare.

- (d) Install supplied spring clip (small) with turned up edge over dimple locations B and C (Fig. 5-3).

7. Install the Rear Mudguard.

⚠ NOTE: Sequence is optional.

- (a) Install supplied M5 x 20mm (Thin) screw in location A while holding part tight to panel and tighten (Fig. 7-1).

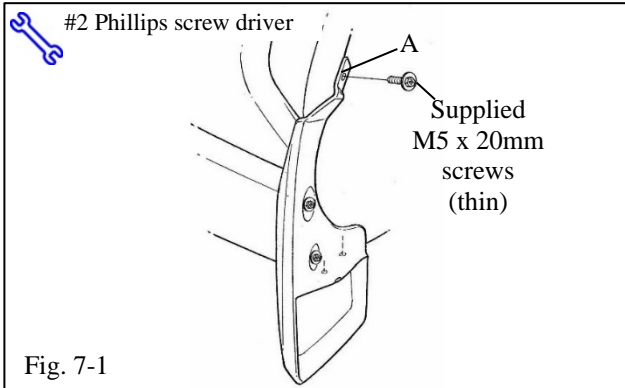

- (b) Mount mudguard on body panel and install supplied M5 x 20mm (thin) screws in location B and C while holding part up and into body panel and tighten (Fig. 7-2).

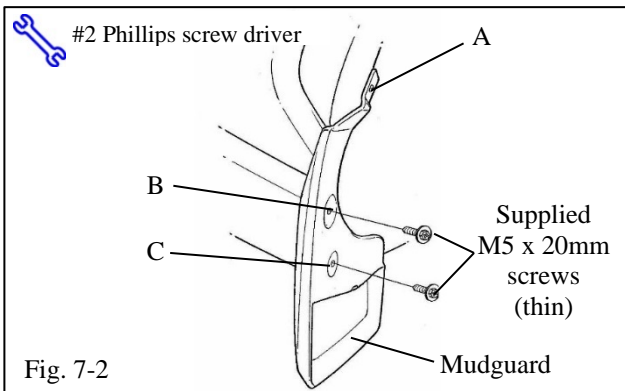

- (c) Reinstall existing screw in location D while holding part up and into panel (Fig. 6-2).

⚠ NOTE: Do not overtighten the screw.

- (d) Install supplied #14 x 19mm (10mm) screw in location E while holding part up and into panel (Fig. 6-2).

⚠ NOTE: Do not overtighten the screw.

- (e) Repeat procedure for other side.

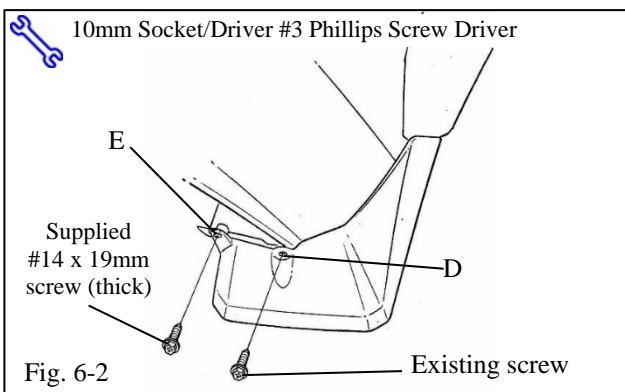

<u>Check:</u>	<u>Look For:</u>
<p><u>Accessory Function Checks</u></p> <p><input type="checkbox"/> Gaps between mudguards and vehicle body or fender flare</p> <p><input type="checkbox"/></p> <p><input type="checkbox"/></p>	<p> Gaps cannot be greater than 3.0mm</p>
<p><u>Vehicle Function Checks</u></p> <p><input type="checkbox"/></p> <p><input type="checkbox"/></p> <p><input type="checkbox"/></p>	
<p><u>Vehicle Appearance Check</u></p> <p><input type="checkbox"/> After accessory installation and removal of protective cover(s), perform a visual inspection.</p>	<p>Ensure no damage (including scuffs and scratches) was caused during the installation process.</p> <p>(For PPO installations, refer to TMS Accessory Quality Shipping Standard.)</p>